



The HydraPanel is a battery-powered LED panel for film, studio and stage lighting. Included with the HydraPanel are six light modifiers consisting of various Diffusers, EggCrates and a GelHolder. The HydraPanel can be mounted with its FlexBase accessory, Babypin and backside magnet. With the ConnectorPlates, up to four panels can be connected to form one bigger panel. For longer installations it can be wired for power and data via an Astera PowerBox.

SPECIFICATIONS



Max 20h



Wireless DMX



IP65



App

Order Code	FP6
LED Engine	Titan LED Engine
Colors	RGBMintAmber
Total LED Power	25 W
LED Power Draw	17 W
Luminous Flux 3200K	1102 Lumens
Luminous Flux 4000K	1287 Lumens
Luminous Flux 5500K	1298 Lumens
Light Output 3200 K @ 1m	443 Lux
Light Output 4000 K @ 1m	512 Lux
Light Output 5500 K @ 1m	516 Lux
CRI (Ra)/ TLCI 3200- 6500 K*	≥ 96
Beam Angle	110° x 100°
Field Angle	150° x 145°
Strobe	0 - 25 Hz
Pixels	6
Battery Runtime	up to 20 hours
Battery Runtime Max Brightness	1h 45m
Battery Lifetime	70 % after 300 cycles
Charging Time (nominal)	3 hours
DC Input	24VDC - 0.85 A
DC Connector	5.5 mm x 2.1 mm
Wired DMX	Yes (via FP1-PWB/FP3-DTL/PWB2-86)
CRMX Receiver	Built-in
BluetoothBridge BTB	Built-in
Wireless Protocols	CRMX, UHF, Bluetooth, WiFi
Wireless Range	CRMX/UHF up to 300 m / 330 yds Bluetooth up to 3 m / 3.3 yds
Infrared Control	Yes
ControlSync	Yes
TouchSlider	Yes
Housing Material	Polymer & Metal
IP Rating	IP65
Ambient Operating Temperature	0 - 40 °C / 32 - 104 °F
Weight	604 g / 1.3 lb
Dimensions L x W x D	166 mm x 85 mm x 43.5 mm / 6.53" x 3.34" x 1.71"

RF CHARACTERISTICS

Wireless Modules	EU: UHF (863-870MHz)	USA: UHF (917-922.20MHz)	AUS: UHF (922.30-927.50MHz)	SGP: UHF (920.50-924.50MHz)	KOR: UHF (917.9-921.5MHz)
Modulation	FHSS	FHSS	FHSS	FHSS	FHSS
ERP (Transmitter)	<25mW	<25mW	<25mW	<25mW	<25mW
Channel Count	47	53	53	41	10
Wireless Modules	RUS: UHF (868.75-869.12MHz)	JPN: UHF (922.80-926.40MHz)	CRMX (2402-2480MHz)	Bluetooth 5.0 LE (2402-2480MHz)	WiFi (2412-2472MHz)
Modulation	FHSS	FHSS	FHSS	FHSS	DSSS, OFDM
ERP (Transmitter)	<25mW	<25mW	-	10mW (BLE)	100mW
Channel Count	6	19	79	40	13

HYDRAPANEL AS BLUETOOTH BRIDGE

Connect the App directly to a HydraPanel via Bluetooth. This light will then transmit commands from the AsteraApp to all other HydraPanels and other Astera lights via the UHF band.

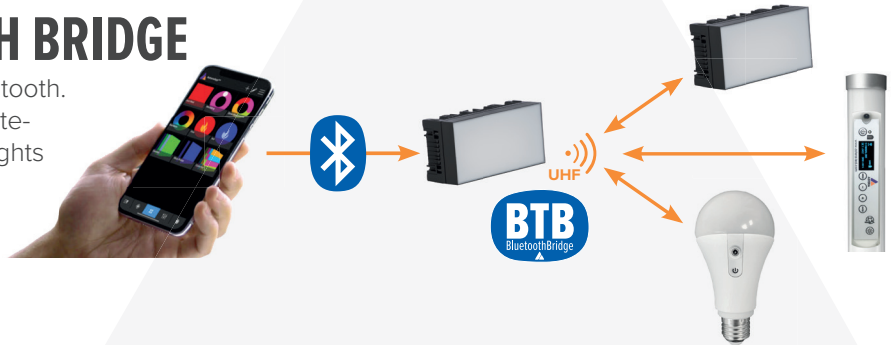

DRAWINGS

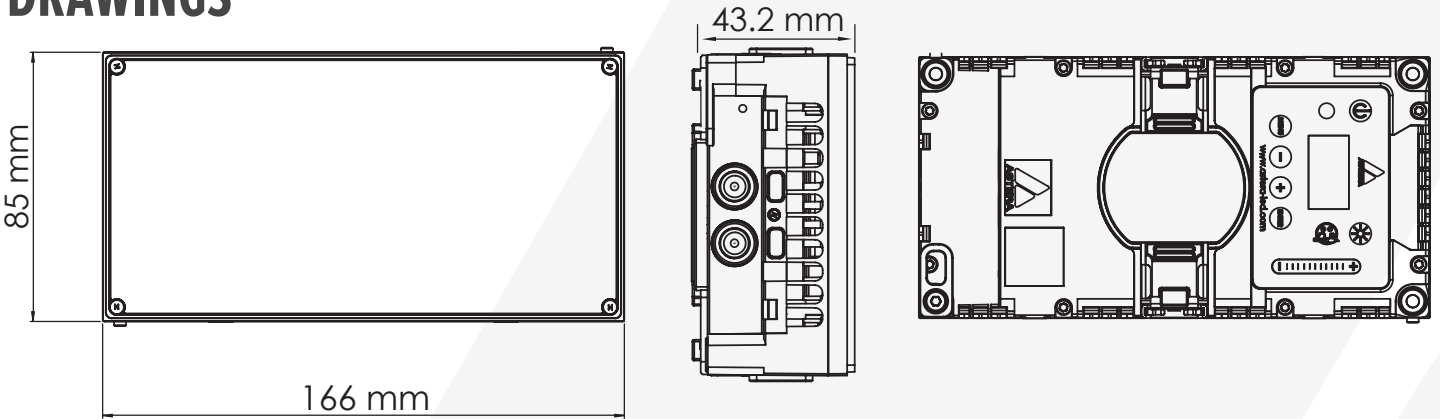

BUILT-IN FEATURES

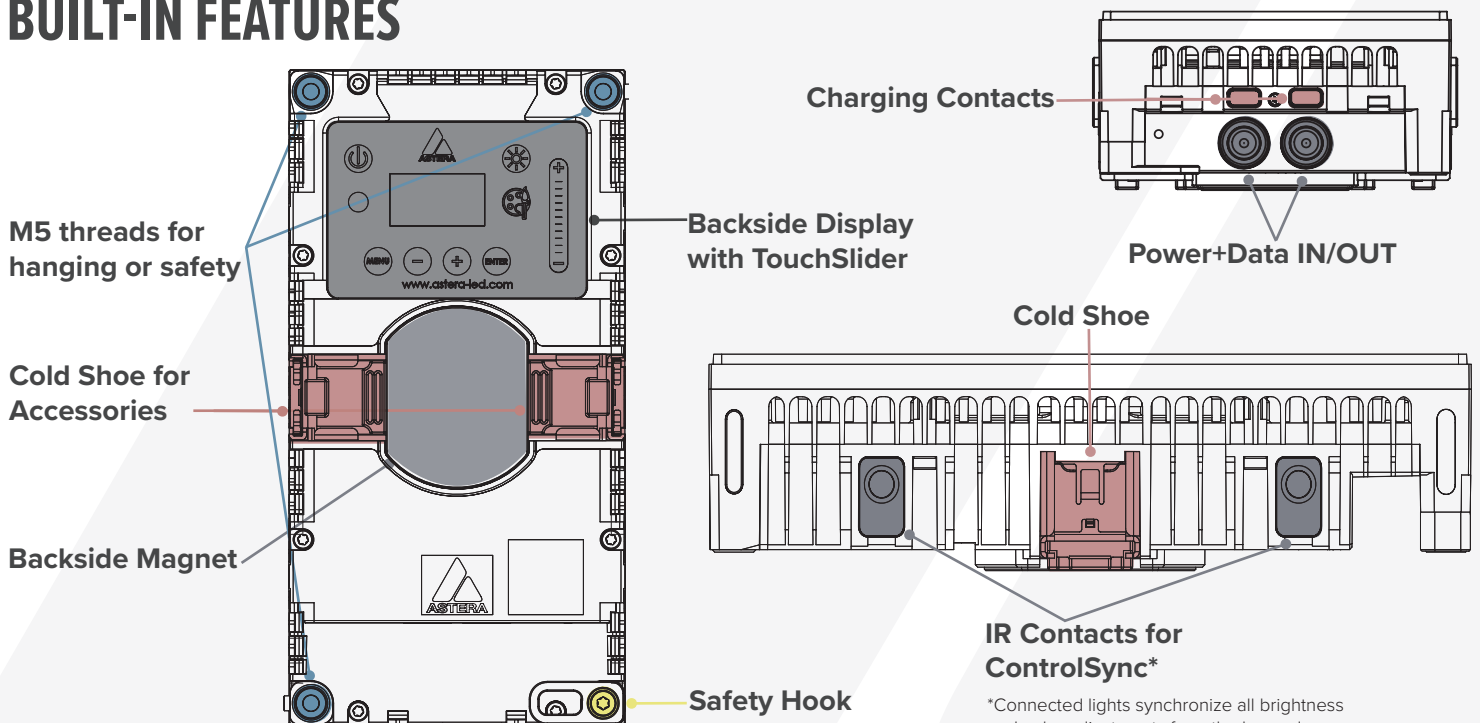

ACCESSORIES

FlexBase
FP6-FB

included



Mounting points

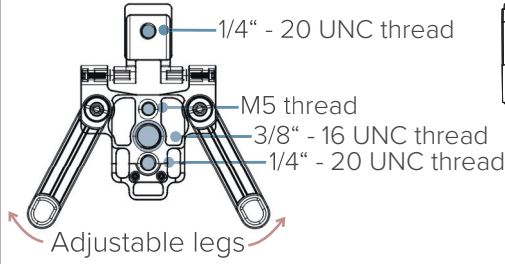

Slide into Cold Shoe

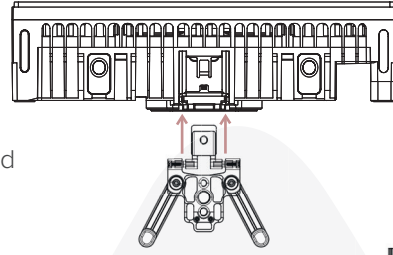

Tiltable

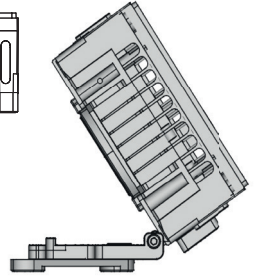

ConnectorPlate
FP6-CP

included

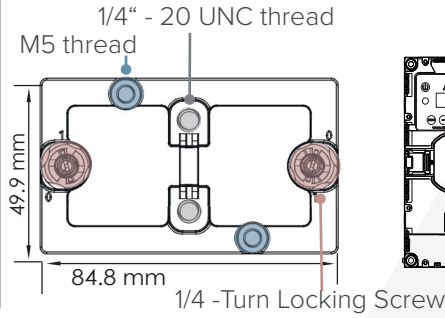

Connect up to 4 HydraPanels

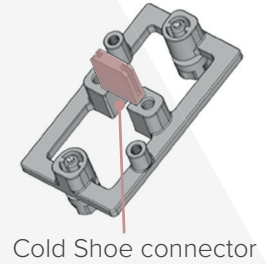
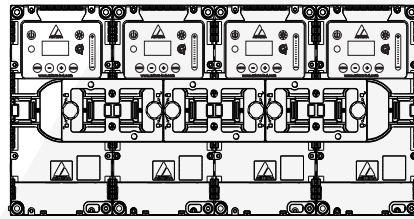

BabyPin 1/4"
AX-BBP-1/4

included



200 mm Power / DataCombination Cable
PWB-CAB-0.2



Power Supply for Helios/ Titan Tube
FP1-CHR



Power Supply for Hyperion Tube
FP3-CHR



EyeBolt
FP1-EBLT



SNAPBAG by DoPchoice
SBATHY11



LIGHT MODIFIERS all included

SoftFrame 100
FP6-SF-100



Intensifier 80
FP6-INT-80



CASES EMPTY
Single Unit Case
FP6-CSE-1



KITS FULL
Single Unit Kit
FP6-SET-1



EggCrate 40
FP6-EGC-40



EggCrate 60
FP6-EGC-60



Charging Case for 4
FP6-CHRCSE-4



Kit for 4
FP6-SET-4



DiffusorSheet 100
FP6-DS-100



GelHolder
FP6-GH



CHARGING & CONNECTING

With PowerBox 2x86 (PWB-2-86) up to four HydraPanels can be connected per output

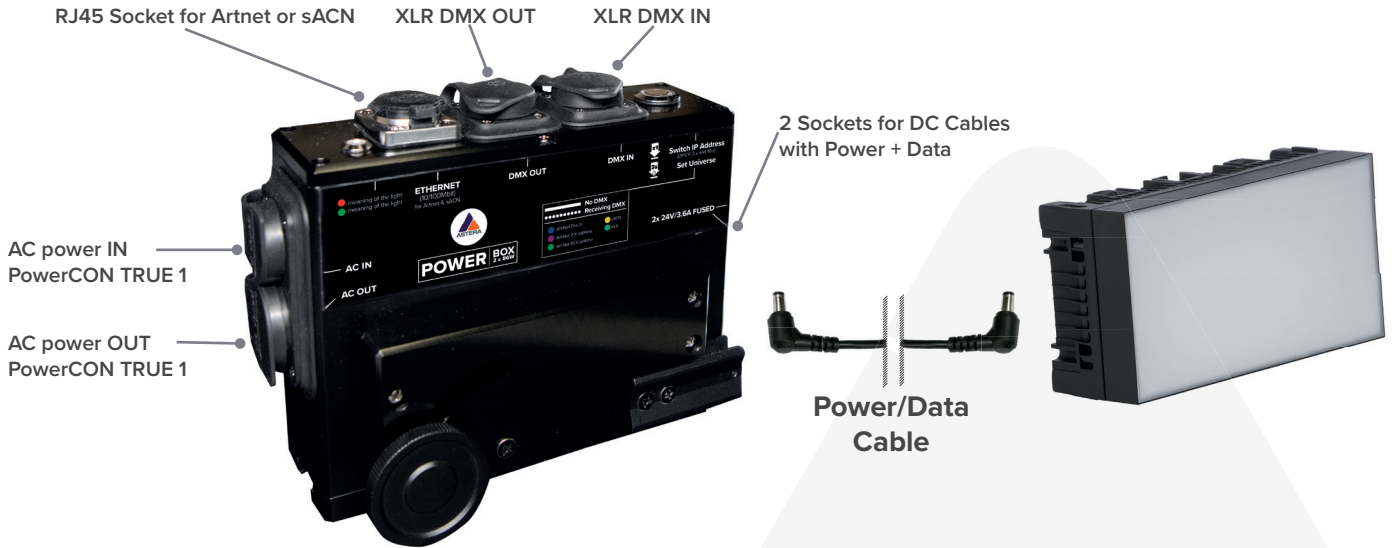

With Titan PowerBox (FP1-PWB) up to two HydraPanels can be connected per output

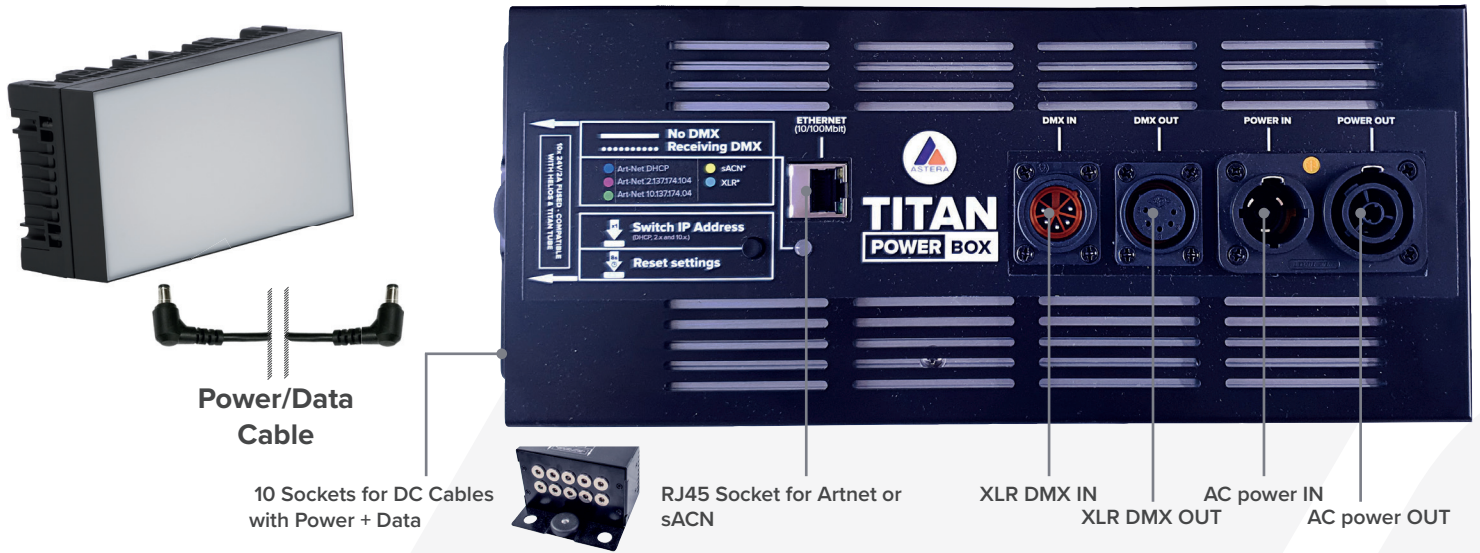

TYPICAL SPECTRAS

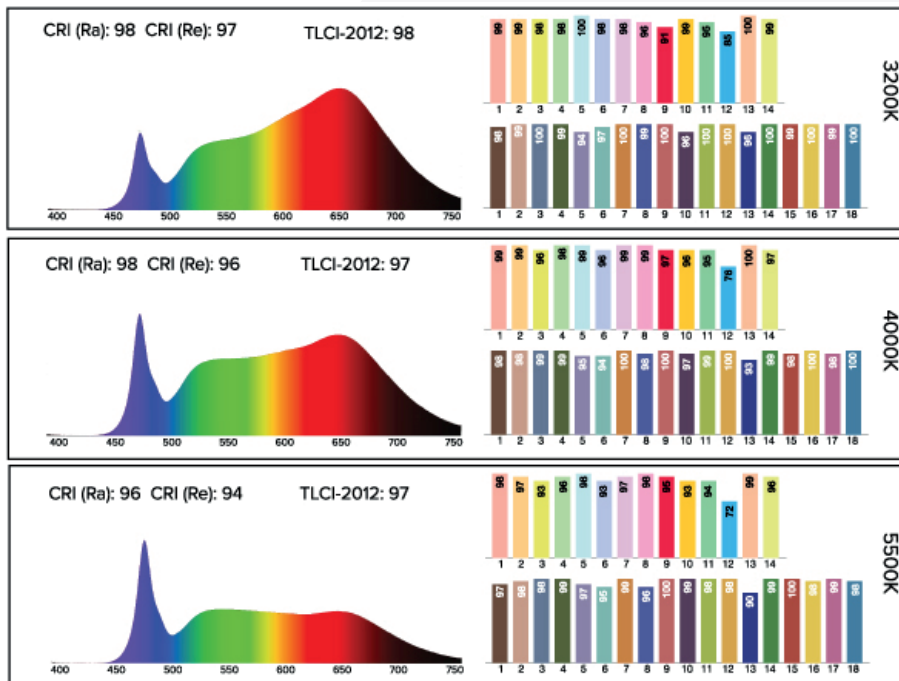

*Typical values